GRYPHON™

Software Configuration Manual



GRYPHON™

SOFTWARE CONFIGURATION MANUAL

This manual refers to
software version 1.0
and later

Datalogic reserves the right to make modifications and improvements without prior notification.

Product names mentioned herein are for identification purposes only and may be trademarks and or registered trademarks of their respective companies.

© - 2000, 2001 Datalogic S.p.A.

Rev. B

CONTENTS

	HOW TO USE THIS MANUAL	v
1	INTRODUCTION	1
1.1	Status Indicators	1
2	INITIAL SETUP	3
	Restore Default	3
	Set Radio Address (M series Only)	3
	Interface Selection	5
3	CONFIGURATION	9
	RS232 PARAMETERS	10
	WEDGE PARAMETERS	16
	PEN EMULATION	22
	DATA FORMAT	28
	POWER SAVE	39
	READING PARAMETERS	43
	DECODING PARAMETERS	51
	CODE SELECTION	55
	ADVANCED FORMATTING	76
	RADIO PARAMETERS	95
4	REFERENCES	97
4.1	RS232 Parameters	97
4.1.1	Handshaking	97
4.1.2	ACK/NACK from Host Protocol	98
4.1.3	FIFO	99
4.1.4	RX Timeout	99
4.2	Pen Parameters	99
4.2.1	Minimum Output Pulse	99
4.2.2	Overflow	100
4.2.3	Output and Idle Levels	100
4.2.4	Inter-Block Delay	101
4.3	Data Format	102
4.3.1	Header/Terminator Selection	102
4.4	Power Save	105
4.4.1	Sleep State	105
4.4.2	Enter Sleep Timeout	105

4.4.3	Standby	105
4.4.4	Power-Off Timeout (M series only)	106
4.5	Reading Parameters	106
4.5.1	Operating Modes.....	106
4.5.2	Hardware Trigger Mode	106
4.5.3	Trigger-Off Timeout.....	107
4.5.4	Reads per Cycle	107
4.5.5	Safety Time	108
4.5.6	Beeper Control for Radio Response (M series only).....	108
4.6	Decoding Parameters.....	108
4.6.1	Ink-Spread	109
4.6.2	Overflow Control.....	109
4.6.3	Interdigit Control	109
4.7	Radio Parameters	109
4.7.1	Radio Protocol Timeout.....	109
4.8	Configuration Editing Commands	110
4.9	Configuration Copying Commands	112
4.9.1	Copy Gryphon™ D-Series.....	112
4.9.2	Copy Gryphon™ M-Series	113
4.9.3	Copy OM-Gryphon	114
APPENDIX A HOST CONFIGURATION STRINGS		115
APPENDIX B CODE IDENTIFIER TABLE		127
APPENDIX C HEX AND NUMERIC TABLE		131

HOW TO USE THIS MANUAL

Your reader is supplied with its own Quick Reference Manual which provides connection diagrams, reading diagrams, basic application parameter settings, default values, and specific technical features. You can use either your reader's Quick Reference Manual or this Manual for initial configuration in order to set the default values and select the interface for your application.

This manual can be used for complete setup and configuration of your reader.

To use this manual for initial setup:

- 1) Read the Restore Default code on page 3.
- 2) Complete the Set Radio Address procedure (for M series only)
- 3) Choose the correct interface selection code for your application from those listed in chapter 2.

If you wish to change the default settings, this manual provides complete configuration of your reader in an easy way.

To configure your reader:

- 1) Open the folded page in [Appendix C](#) with the hex-numeric table and keep it open during the device configuration.
- 2) Read the **Enter Configuration** code ONCE, available at the top of each page of configuration.
- 3) Modify the desired parameters in one or more sections following the procedures given for each group.
- 4) Read the **Exit and Save Configuration** code ONCE, available at the top of each page of configuration.

Reference notes describing the operation of the more complex parameters are given in chapter 4.

Copy Command

A previously configured device (Master), can be used to send its configuration directly to other devices of the same type (Slaves). The particular procedure for each device is given in par. 4.9.

Sending Configuration Strings from Host

An alternative configuration method is provided in Appendix A using the RS232 interface. This method is particularly useful when many devices need to be configured with the same settings. Batch files containing the desired parameter settings can be prepared to configure devices quickly and easily.

If this method is used for M-series readers, the Get Configuration command is required. See par. 4.9.2 for details.

Services Available at Our Web Site:

By completing the electronic form at our website, www.datalogic.com/hhd/gryphon_utilities.htm, you have free access to download the following items:

- **WinSetPlus™**
A Windows-based utility program allows device configuration using a PC. It provides direct RS232 interface configuration as well as configuration barcode printing.
- **Loader:**
The utility program necessary to load the application software (upgrades) onto your reader.
- **Software Upgrades:**
Software upgrades for your reader to keep you updated with the latest improvements.
- **Configuration Manual**
This manual and its relative updates can be downloaded for printing or used for online consultation.

These items are also available from your local Datalogic distributor.

1 INTRODUCTION

This manual provides all the necessary information for complete software configuration.

This product contains a built-in decoder and multi-standard interface.

It is designed for use in a wide variety of applications and environments including **commercial**, **office automation**, **retail**, and **light industrial** applications where large quantities of information need to be collected rapidly, easily and reliably.

1.1 STATUS INDICATORS

The reader has three indicators, LED, Beeper and Good Read Spot. They signal several operating conditions which are described in the tables below.

POWER UP

Beeper ¹	Meaning
L L L L	Parameters loaded correctly
H H H H long tones	Parameter loading error, reading or writing error in the non volatile memory
H L H L	Hardware error in EEPROM

CONFIGURATION

Beeper ¹	Meaning
H H H H	correct entry or exit from Configuration mode
L	good read of a command
L L L	command read error

DATA ENTRY

Beeper ¹	LED	Good Read Spot	Meaning
one beep ²	ON	ON	correct read of a code in normal mode
H long	ON	ON	successful advanced format concatenation
H H H			timeout expired – operation not completed
H H long			error in advanced data formatting
	OFF	OFF	ready to read a code
H L long			tx buffer full (when FIFO is enabled) or tx error between Gryphon M and OM Gryphon

¹ Only the Beeper Intensity command can modify these signals.

² The data entry good read tone is user-configurable with all the Beeper commands in the Reading Parameters section.

For M-series readers, normally this results in two beeps; the first indicates that the reader has decoded the code, the second indicates whether OM Gryphon has received the data. See also par. 4.5.6.

H = high tone

L = low tone

2 INITIAL SETUP

RESTORE DEFAULT

Read the restore default parameters code below.

1. **Restore Gryphon™ Default**



For D-Series readers, after reading the above code, skip to step 8, Interface Selection.

SET RADIO ADDRESS (M SERIES ONLY)

Follow the procedure below to set the radio address and bind Gryphon™ M to the OM-Gryphon cradle.

2. **Enter configuration**



3. **Set Radio Address**



+

four digits from Appendix C for the Gryphon™ Address (from 0000 to 1999).

All readers used in the same area must have different addresses.

4. **Exit and Save configuration**



5. Read the **Bind** code to pair the Gryphon™ M to the cradle. The reader is dedicated to the cradle. Any previously **bound** reader will be excluded.

Bind



The green LED on the Gryphon™ will go on; the reader is ready to be inserted into the cradle.

6. Firmly insert the reader into the cradle, a beep will be emitted, signalling that the OM-GRYPHON cradle has been paired to the Gryphon™, and the green LED on the reader will go off.

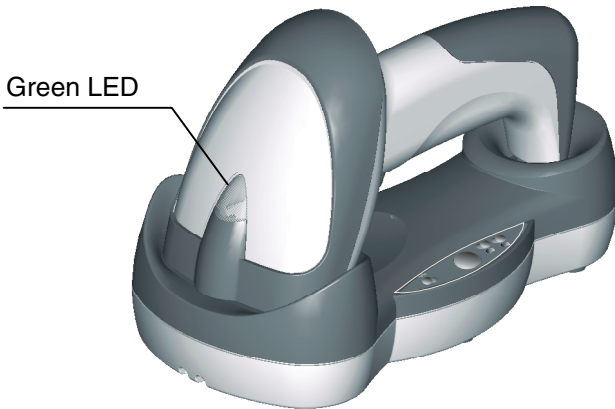

7. Read the OM-GRYPHON restore default code:

Restore OM-GRYPHON default



INTERFACE SELECTION

8. Read the interface selection code for your application.

RS232



PEN



WEDGE

IBM AT or PS/2 PCs

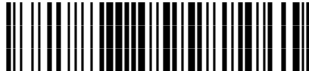

IBM XT



PC Notebook

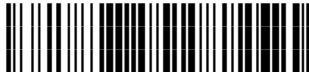

IBM SURE1



IBM Terminal 3153

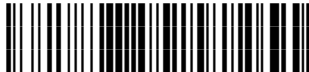

WEDGE (continued)

IBM Terminals 31xx, 32xx, 34xx, 37xx:

To select the interface for these IBM Terminals, read the correct KEY TRANSMISSION code. Select the KEYBOARD TYPE if necessary (default = advanced keyboard).

KEY TRANSMISSION MODE

make-only keyboard



make-break keyboard



KEYBOARD TYPE

◆ advanced keyboard



typewriter keyboard



WEDGE (continued)

ALT MODE

The ALT-mode selection allows barcodes sent to the PC to be interpreted correctly independently from the Keyboard Nationality used. **You do not need to make a Keyboard Nationality selection.**

(default = Num Lock Unchanged). **Make sure the Num Lock key on your keyboard is ON.**

IBM AT - ALT mode

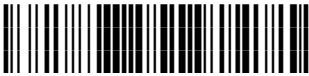

PC Notebook - ALT mode



WYSE TERMINALS

ANSI Keyboard



PC Keyboard



ASCII Keyboard



VT220 style Keyboard



WEDGE (continued)

DIGITAL TERMINALS

VT2xx/VT3xx/VT4xx



APPLE

APPLE ADB Bus

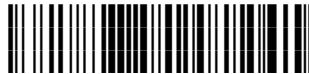

YOUR READER IS NOW READY TO READ BARCODES.

To change the defaults see Chapter 3.

3 CONFIGURATION

Once your reader is setup, you can change the default parameters to meet your application needs. Refer to chapter 2 for initial configuration in order to set the default values and select the interface for your application.

In this manual, the configuration parameters are divided into logical groups making it easy to find the desired function based on its reference group.

The first three groups are for Standard Interface parameter configuration:

- **RS232**
- **WEDGE**
- **PEN EMULATION**

The following parameter groups are common to all interface applications:

DATA FORMAT parameters regard the messages sent to the Host system for all interfaces except Pen Emulation.

POWER SAVE manages overall current consumption in the reading device.

READING PARAMETERS control various operating modes and indicator status functioning.

DECODING PARAMETERS maintain correct barcode decoding in certain special reading conditions.

CODE SELECTION parameters allow configuration of a personalized mix of codes, code families and their options.

ADVANCED FORMATTING PARAMETERS allow code concatenation and advanced formatting of messages towards the Host.

RADIO PARAMETERS (M series only) allow configuration of radio protocol timeouts.

RS232 PARAMETERS

PARAMETERS

BAUD RATE
PARITY
DATA BITS
STOP BITS
HANDSHAKING
ACK/NACK FROM HOST PROTOCOL
FIFO
INTER-CHARACTER DELAY
RX TIMEOUT

1. Read the **Enter Configuration** code ONCE, available at the top of each page.

2. Read configuration codes from the desired groups.



= Read the code and follow the procedure given

3. Read the **Exit and Save Configuration** code ONCE, available at the top of each page.



BAUD RATE

150 baud



300 baud



600 baud



1200 baud



2400 baud



4800 baud



◆ 9600 baud



19200 baud



38400 baud





RS232



PARITY

◆ none



even parity



odd parity



DATA BITS

7 bits



◆ 8 bits

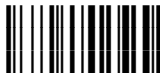

9 bits





STOP BITS

◆ 1 stop bit



2 stop bits



HANDSHAKING

◆ disable



hardware (RTS/CTS)



software (XON/XOFF)



See par. 4.1.1 for details.



ACK/NACK FROM HOST PROTOCOL

◆ disable



enable



See par. 4.1.2 for details, particularly on implementing this parameter with Gryphon M.

FIFO

disable



◆ enable



See par. 4.1.3 for details.



INTER-CHARACTER DELAY

delay between characters transmitted to Host



Read 2 numbers from the table where:

- 00 = DELAY disabled
- 01-99 = DELAY from 1 to 99 milliseconds

◆ delay disabled

RX TIMEOUT

timeout control in reception from Host



Read 2 numbers from the table where:

- 00 = TIMEOUT disabled
- 01-99 = TIMEOUT from .1 to 9.9 seconds

◆ rx timeout 5 seconds

See par. 4.1.4 for details.

WEDGE PARAMETERS

PARAMETERS

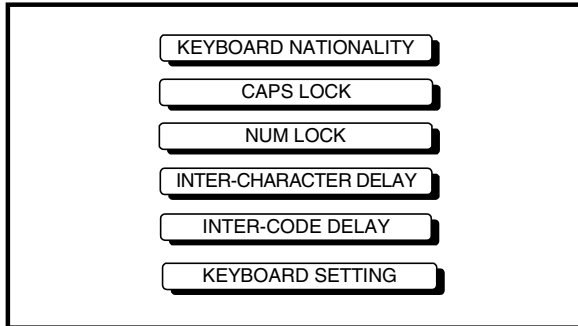

1. Read the **Enter Configuration** code ONCE, available at the top of each page.

2. Read configuration codes from the desired groups.



= Read the code and follow the procedure given

3. Read the **Exit and Save Configuration** code ONCE, available at the top of each page.



KEYBOARD NATIONALITY

Belgian



English



French



German



Italian

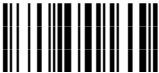

Spanish



Swedish



◆ USA





CAPS LOCK

◆ caps lock OFF



caps lock ON



Select the appropriate code to match your keyboard caps lock status.

Note: For **PC Notebook** interface selections, the caps lock status is automatically recognized, therefore this command is not necessary.

NUM LOCK

toggle num lock



◆ num lock unchanged



This selection is used together with the Alt Mode interface selection for AT or Notebook PCs.

It changes the way the Alt Mode procedure is executed, therefore it should be set as follows:

- if your keyboard Num Lock is normally on use **num lock unchanged**
- if your keyboard Num Lock is normally off use **toggle num lock**

In this way the device will execute the Alt Mode procedure correctly for your application.



INTER-CHARACTER DELAY



delay between characters transmitted to Host



Read 2 numbers from the table where:

00 = DELAY disabled
01-99 = DELAY from 1 to 99 milliseconds

◆ delay disabled

INTER-CODE DELAY



delay between codes transmitted to Host



Read 2 numbers from the table where:

00 = DELAY disabled
01-99 = DELAY from 1 to 99 seconds

◆ delay disabled



KEYBOARD SETTING

ALPHANUMERIC KEYBOARD SETTING

The reader can be used with terminals or PCs with various keyboard types and nationalities through a simple keyboard setting procedure.

The type of computer or terminal must be selected before activating the keyboard setting command.

Keyboard setting consists of communicating to the reader how to send data corresponding to the keyboard used in the application. The keys must be set in a specific order.

Press and release a key to set it.

Some characters may require more than one key pressed simultaneously during normal use (refer to the manual of your PC or terminal for keyboard use). The exact sequence must be indicated to the reader in this case pressing and releasing the different keys.

Example:

If one has to press the "Shift" and "4" keys simultaneously on the keyboard to transmit the character "\$" to the video, to set the "\$", press and release "Shift" then press and release "4".

Each pressed and released key must generate an acoustic signal on the reader, otherwise repress the key. Never press more than one key at the same time, even if this corresponds to the normal use of your keyboard.

Press "Backspace" to correct a wrong key entry. In this case the reader emits 2 beeps.

Note: "CAPS LOCK" and "NUM LOCK" must be off before starting the keyboard setting procedure. "SHIFT" must be repressed for each character and cannot be substituted by "CAPS LOCK".



setting the alphanumeric keyboard



Read the code above.

Press the keys shown in the following table according to their numerical order:

WEDGE

Some ASCII characters may be missing as this depends on the type of keyboard: these are generally particular characters relative to the various national symbolologies. In this case:

- **The first 4 characters (Shift, Alt, Ctrl, and Backspace) can only be substituted with keys not used, or substituted with each other.**
- characters can be substituted with other single symbols (e.g. "SPACE") even if not included in the barcode set used.
- characters can be substituted with others corresponding to your keyboard.

The reader signals the end of the procedure with 2 beeps indicating the keys have been registered.

01 : Shift		
02 : Alt		
03 : Ctrl		
04 : Backspace		
05 : SPACE	28 : 7	51 : N
06 : !	29 : 8	52 : O
07 : "	30 : 9	53 : P
08 : #	31 : :	54 : Q
09 : \$	32 : ;	55 : R
10 : %	33 : <	56 : S
11 : &	34 : =	57 : T
12 : '	35 : >	58 : U
13 : (36 : ?	59 : V
14 :)	37 : @	60 : W
15 : *	38 : A	61 : X
16 : +	39 : B	62 : Y
17 : ,	40 : C	63 : Z
18 : -	41 : D	64 : [
19 : .	42 : E	65 : \
20 : /	43 : F	66 :]
21 : 0	44 : G	67 : ^
22 : 1	45 : H	68 : _ (underscore)
23 : 2	46 : I	69 : `
24 : 3	47 : J	70 : {
25 : 4	48 : K	71 :
26 : 5	49 : L	72 : }
27 : 6	50 : M	73 : ~
		74 : DEL

PEN EMULATION

PARAMETERS

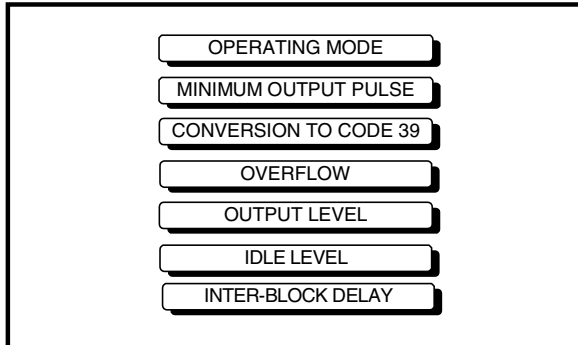

- 1.** Read the **Enter Configuration** code ONCE, available at the top of each page.
- 2.** Read configuration codes from the desired groups.
- 3.** Read the **Exit and Save Configuration** code ONCE, available at the top of each page.

PEN EMULATION

The operating mode parameters are complete commands and do not require reading the Enter and Exit configuration codes.

OPERATING MODE

◆ interpret mode



Interprets commands without sending them to the decoder.

transparent mode



Sends commands to the decoder without interpreting them.



PEN EMULATION



MINIMUM OUTPUT PULSE

high resolution code emulation



low resolution code emulation

See par. 4.2.1 for details.



CONVERSION TO CODE 39

◆ disable



Transmits codes in their original format.

enable



Converts codes read into Code 39 format.

The following codes are ALWAYS converted into Code 39 format:
 Codablock-A, Codablock-F Standard and EAN, MSI, Plessey, Telepen, Delta IBM, Code 11,
 Code 16K, Code 49, PDF417

For M-series readers, all codes are ALWAYS converted into Code 39 format.

OVERFLOW

narrow



◆ medium



wide



See par. 4.2.2 for details.



PEN EMULATION



OUTPUT LEVEL

◆ normal
(white = logic level 0)



inverted
(white = logic level 1)



See par. 4.2.3 for details.

IDLE LEVEL

◆ normal
(black level)



inverted
(white level)

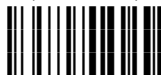

See par. 4.2.3 for details.

**INTER-BLOCK DELAY**

delay between character blocks transmitted to Host



Read 2 numbers from the table where:

00 = DELAY disabled

01-99 = DELAY from .1 to 9.9 seconds

◆ DELAY disabled

See par. 4.2.4 for details

DATA FORMAT

NOT FOR PEN INTERFACES

PARAMETERS

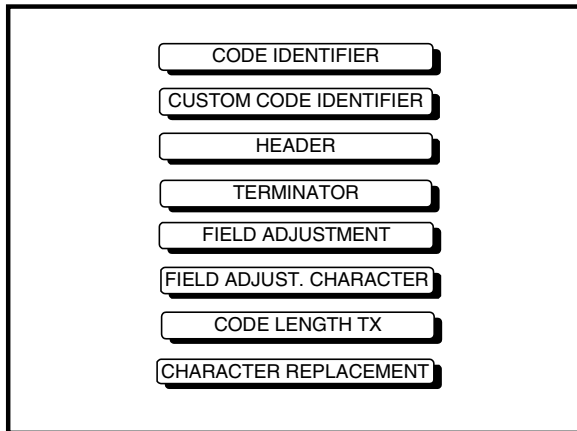

1. Read the **Enter Configuration** code ONCE, available at the top of each page.

2. Read configuration codes from the desired groups.



= Read the code and follow the procedure given

3. Read the **Exit and Save Configuration** code ONCE, available at the top of each page.

DATA FORMAT

CODE IDENTIFIER TABLE			
CODE	AIM STANDARD	DATALOGIC STANDARD	Custom
2/5 interleaved] I y	N	
2/5 industrial] X y	P	
2/5 normal 5 bars] S y	O	
2/5 matrix 3 bars] X y	Q	
EAN 8] E 4	A	
EAN 13] E 0	B	
UPC A] X y	C	
UPC E] X y	D	
EAN 8 with 2 ADD ON] E 5	J	
EAN 8 with 5 ADD ON] E 6	K	
EAN 13 with 2 ADD ON] E 1	L	
EAN 13 with 5 ADD ON] E 2	M	
UPC A with 2 ADD ON] X y	F	
UPC A with 5 ADD ON] X y	G	
UPC E with 2 ADD ON] X y	H	
UPC E with 5 ADD ON] X y	I	
Code 39] A y	V	
Code 39 Full ASCII] A y	W	
CODABAR] F y	R	
ABC CODABAR] X y	S	
Code 128] C y	T	
EAN 128] C y	k	
ISBT 128] C4	f	
Code 93] G y	U	
CIP/39] X y	Y	
CIP/HR] X y	e	
Code 32] X y	X	
Codablock-A] O 6	n	
Codablock-F Std] O 4	l	
Codablock-F EAN] O 5	m	
MSI] M y	Z	
Plessey Standard] P 0	a	
Plessey Anker] P 1	o	
Telepen] X 0	d	
Delta IBM] X 0	c	
Code 11] H y	b	
Code 16K] K 0	p	
Code 49] T y	q	
PDF417] L 0	r	

DATA FORMAT

- AIM standard identifiers are not defined for all codes: the X identifier is assigned to the code for which the standard is not defined. The y value depends on the selected options (check digit tested or not, check digit tx or not, etc.).
- When customizing the Datalogic Standard code identifiers, 1 or 2 identifier characters can be defined for each code type. If only 1 identifier character is required, the second character must be selected as **FF** (disabled).
- The code identifier can be singly disabled for any code by simply selecting **FF** as the first identifier character.
- Write in the Custom character identifiers in the table above for your records.



DATA FORMAT



CODE IDENTIFIER

◆ disable



Datalogic standard



AIM standard



custom





CUSTOM CODE IDENTIFIER



define custom code identifier(s)



- ① Read the above code.
(Code Identifiers default to Datalogic standard, see table on previous page).
- ② Select the code type from the code table in Appendix B for the identifier you want to change.
- ③ You can define 1 or 2 identifier characters for each code type. If only 1 identifier character is required, the second character must be selected as **FF** (disabled). Read the hexadecimal value corresponding to the character(s) you want to define as identifiers for the code selected in step ②: valid characters are in the range **00-7F**.

Example: To define Code 39 Code Identifier = @





HEADER

no header



one character header



two character header



three character header



four character header



five character header



six character header



seven character header



eight character header



After selecting **one** of the desired Header codes, read the character(s) from the HEX table.

Valid characters for D-series readers are in the range: **00-7F** for RS232 **00-9B** for WEDGE

Valid characters for M-series readers are in the range: **00-FF** for RS232 and WEDGE

Example:

four character header



+ 41 + 42 + 43 + 44 = Header **ABCD**

For more details about default and WEDGE Interface Extended Keyboard values, see par. 4.3.1.



DATA FORMAT



TERMINATOR

no terminator



one character terminator



two character terminator



three character terminator



four character terminator



five character terminator

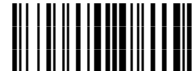

six character terminator



seven character terminator



eight character terminator



After selecting **one** of the desired Terminator codes, read the character(s) from the HEX table.

Valid characters for D-series readers are in the range: **00-7F** for RS232 **00-9B** for WEDGE

Valid characters for M-series readers are in the range: **00-FF** for RS232 and WEDGE

Example:

two character terminator



+ 0D + 0A = Terminator CR LF

For more details about default and WEDGE Interface Extended Keyboard values, see par. 4.3.1.



FIELD ADJUSTMENT

◆ disable field adjustment



Field adjustment allows a number of characters n , to be added to or subtracted from the barcode read. The adjustment can be different for each enabled code type. To define the field adjustment:

① Read the enable field adjustment code:

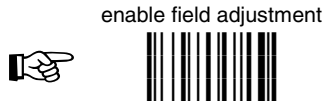

② Select the code type from the Code Identifier Table in Appendix B.

③ Select the type of adjustment to perform:

right addition



left addition



right deletion



left deletion



④ Read a number in the range **01 - 32** from the Hex/Numeric Table to define how many characters to add or delete:

Conditions:

- Adjustment is only performed on the barcode data, the Code Identifier and Code Length Transmission fields are not modified by the field adjustment parameter.
- If the field setting would subtract more characters than exist in the barcode, the subtraction will take place only to code length 0.

Example: To add 4 characters to the right of Standard Code 39 Codes:

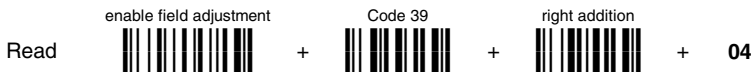



FIELD ADJUST. CHARACTER

- ① Read the field adjustment character code:

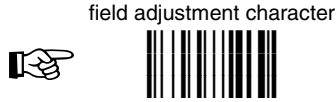

- ② Read the hexadecimal value corresponding to the character you want to use for field adjustment.

Valid characters are in the range: **00-7F** for D-series readers.

00-FF for M-series readers.

Example:

To define the field adjustment character = **A**:



CODE LENGTH TX

- ◆ code length not transmitted



code length transmitted in variable-digit format



code length transmitted in fixed 4-digit format



The code length is transmitted in the message after the Headers and Code Identifier characters. The code length is *calculated* after performing any field adjustment operations.



CHARACTER REPLACEMENT

◆ disable character replacement



This parameter allows up to three characters to be replaced from the barcode read. These substitutions are stored in memory. To define each character replacement:

- ① Read one of the following character replacement codes:



first character replacement



second character replacement



third character replacement

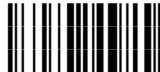

- ② From the Code Identifier Table in Appendix B, read the Code Identifier for the desired code family.
0 = character replacement will be effective for all code families.
- ③ From the Hex/Numeric Table read two characters corresponding to the Hex value which identifies the character to be replaced. Valid values are in the range **00-7F** for D-series readers, **00-FE** for M-series readers.
- ④ From the Hex/Numeric Table read two characters corresponding to the Hex value which identifies the new character to replace. Valid values are in the range **00-7F** for D-series readers, **00-FE** for M-series readers.

FF = the character to be replaced will be substituted with no character, that is, it will be removed from the code.

DATA FORMAT

Example:

The following strings define:

1. *First Character Replacement:* substitution in *Code 39 barcodes* of all occurrences of the **0** character with the **1** character.
2. *Second Character Replacement:* substitution in *Code 39 barcodes* of all occurrences of the **A** character with the **B** character.

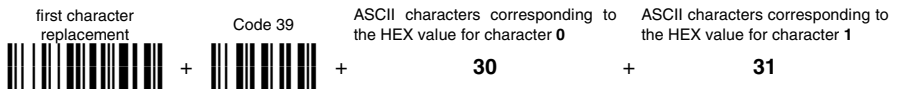

For Code 39 codes containing the string "0123", the contents transmitted will be "1123".

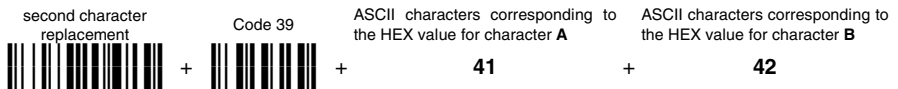

For Code 39 codes containing the string "ABCD", the contents transmitted will be "BBCD".

POWER SAVE

PARAMETERS

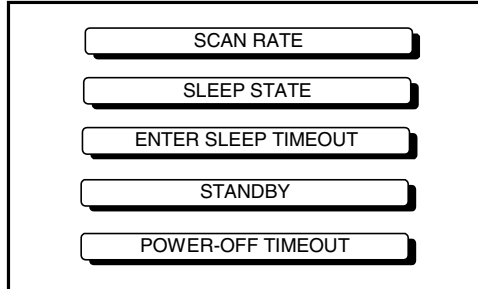

1. Read the **Enter Configuration** code ONCE, available at the top of each page.

2. Read configuration codes from the desired groups.



= Read the code and follow the procedure given

3. Read the **Exit and Save Configuration** code ONCE, available at the top of each page.



POWER SAVE



SCAN RATE

67 scans per sec.



135 scans per sec.



◆ 270 scans per sec.



A lower scan rate reduces power consumption but can lengthen reading response time.

SLEEP STATE

◆ disable



enable



See par. 4.4.1 for details.

For M-series readers, sleep state is entered immediately after reading a code and is not configurable.



POWER SAVE



ENTER SLEEP TIMEOUT



enter sleep timeout



Read 2 numbers in the range 00-99:

00 = Enter Sleep state immediately

01-99 = corresponds to a max. 9.9 sec. delay before entering the Sleep state.

See par. 4.4.2 for details.

STANDBY

◆ disable



optimize for reading speed

enable



optimize for low power consumption

See par. 4.4.3 for details.

For M-series readers, standby is always enabled and is not configurable.



POWER SAVE



POWER-OFF TIMEOUT

M SERIES ONLY

power-off timeout



Read 2 numbers in the range 00-99:

00 = Power-off disabled; reader always ready

01-99 = corresponds to a max. 99 hour delay before power-off.

- ◆ power-off after 4 hours.

See par. 4.4.4 for details.

READING PARAMETERS

PARAMETERS

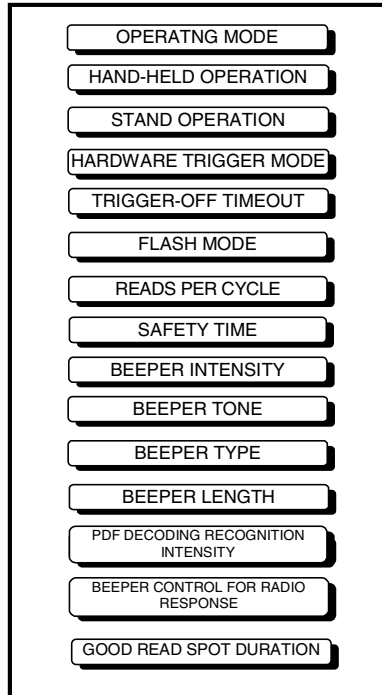

1. Read the **Enter Configuration** code ONCE, available at the top of each page.

2. Read configuration codes from the desired groups.



= Read the code and follow the procedure given

3. Read the **Exit and Save Configuration** code ONCE, available at the top of each page.



READING PARAMETERS



OPERATING MODE

You can pre-configure both Hand-Held and Stand operating modes, and with the codes below, you can switch between them. See par. 4.5.1 for details. Stand operation is not advised for M-Series readers since it constantly consumes battery power.

◆ hand-held operation



automatic

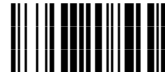

stand operation

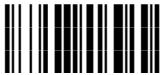

HAND-HELD OPERATION

◆ hardware trigger

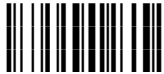

software trigger



hardware trigger ready



automatic



*always on



* not available for M-series readers



READING PARAMETERS



STAND OPERATION

hardware trigger



software trigger



*always on



◆ automatic



* not available for M-series readers

HARDWARE TRIGGER MODE

◆ trigger active level



trigger active pulse



See par. 4.5.2 for details.



READING PARAMETERS



TRIGGER-OFF TIMEOUT



trigger-off timeout



Read 2 numbers in the range 00-99:

00 = disables the trigger-off timeout
 01-99 = corresponds to a max. 99 sec. delay after the trigger press to allow the reader to turn off automatically.

◆ trigger-off timeout disabled

See par. 4.5.3 for details.

FLASH MODE



"FLASH" ON duration



"FLASH" OFF duration



Read 2 numbers in the range 01-99:

01 to 99 = from .1 to 9.9 seconds.

◆ Flash-ON = 1 sec. Flash-OFF = 0.6 sec



READING PARAMETERS



READS PER CYCLE

- ◆ one read per cycle



multiple reads per cycle



See par. 4.5.4 for details.

SAFETY TIME



safety time



Limits same code consecutive reading.

Read 2 numbers in the range 00-99:

00 = no same code consecutive reading until reader is removed (no decoding) for at least 400 ms.

01 to 99 = timeout from .1 to 9.9 seconds before a consecutive read on same code.

- ◆ safety time = 0.5 sec

See par. 4.5.5 for details.



READING PARAMETERS



BEEPER INTENSITY

* very low intensity



low intensity



medium intensity



◆ high intensity



* This sets the beeper OFF for data entry, while for all other beeper signals it has the meaning very low intensity.

The Intensity parameter is effective for all operating conditions described in par. 1.1.

BEEPER TONE

tone 1



◆ tone 2



tone 3



tone 4





READING PARAMETERS



BEEPER TYPE

◆ monotone



bitonal



BEEPER LENGTH

long



◆ short



PDF DECODING RECOGNITION INTENSITY

◆ low



high





READING PARAMETERS



BEEPER CONTROL FOR RADIO RESPONSE

M SERIES ONLY

◆ normal



only good decode



only good reception



off



See par. 4.5.6 for details.

GOOD READ SPOT DURATION

disable



short



◆ medium



long



DECODING PARAMETERS

PARAMETERS

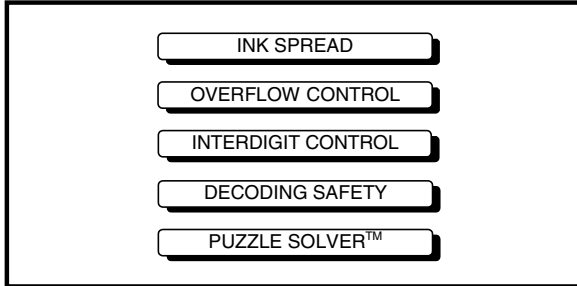

CAUTION

Before changing these parameter values
read the descriptions in par. 4.6.

- 1.** Read the **Enter Configuration** code ONCE, available at the top of each page.
- 2.** Read configuration codes from the desired groups.
- 3.** Read the **Exit and Save Configuration** code ONCE, available at the top of each page.



DECODING PARAMETERS



INK-SPREAD

disable



◆ enable



See par. 0 for details.

OVERFLOW CONTROL

disable



◆ enable



See par. 4.6.2 for details.



DECODING PARAMETERS



INTERDIGIT CONTROL

disable



◆ enable



See par. 4.6.3 for details.

DECODING SAFETY

◆ one read



(decoding safety disabled)

two reads



three reads



four reads



Required number of good reads before accepting code.



PUZZLE SOLVER™

◆ disable



enable



In the case of damaged or poorly printed codes, this parameter allows reading multiple parts of the single code to reconstruct it.

To read codes using this technology, simply move the illuminated bar over the code so that each line of the code is scanned. During this process a series of brief "ticks" indicates that reading is proceeding correctly.

Conditions:

- This parameter is only valid for the following codes:

EAN 8 without Add-on	EAN 13 without Add-on	UPC A without Add-on
Code 128	Code 39	

- Codablock-A and Codablock-F codes are automatically disabled.
- For Code 39, Check digit control without transmission is forced.
- PuzzleSolver™ is disabled when code ISBT 128 is enabled.

CODE SELECTION

PARAMETERS

EAN/UPC FAMILY
2/5 FAMILY
CODE 39 FAMILY
CODE 128 FAMILY
CODABAR FAMILY
CODE 93
CODABLOCK-A
CODABLOCK-F
MSI
PLESSEY
TELEPEN
DELTA IBM
CODE 11
CODE 16K
CODE 49
PDF417

PDF READERS ONLY

1. Read the **Enter Configuration** code ONCE, available at the top of each page.
2. Read configuration codes from the desired groups.
 = Read the code and follow the procedure given
3. Read the **Exit and Save Configuration** code ONCE, available at the top of each page.



DISABLES ALL CODE FAMILIES



NOTE

The reader allows up to 5 code selections. This does not limit the number of CODES enabled to 5, as it depends on the code family:

**SINGLE
SELECTIONS =**

- ONE combination code from the EAN family
- ONE code from the 2/5 family

Example

5 code selections:

1. **2/5 Interleaved**
2. **2/5 Industrial**
3. Code 128 + EAN 128
4. Code 39 Full ASCII + Code 32
5. **UPC A/UPC E**

In this section all SINGLE code selections are underlined and in bold.



CODE SELECTION



EAN/UPC FAMILY

disable the family



① Read the desired family code

Note:

Since the EAN/UPC without ADD ON code selection is enabled by default, to correctly enable another selection, first disable the family.

EAN 8/EAN 13/UPC A/UPC E with and without ADD ON



WITHOUT ADD ON

◆ EAN 8/EAN 13/UPC A/UPC E



EAN 8/EAN 13



UPC A/UPC E



Enter configuration



CODE SELECTION

Exit and Save configuration



WITH ADD ON 2 AND 5

EAN 8/EAN 13/UPC A/UPC E



EAN 8/EAN 13

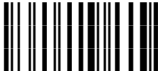

UPC A/UPC E



WITH ADD ON 2 ONLY

EAN 13



UPC A/UPC E



WITH ADD ON 5 ONLY

EAN 8/EAN 13

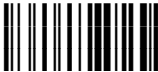

UPC A/UPC E





CODE SELECTION



EAN/UPC CHECK DIGIT TX SELECTIONS

For each code type in this family you can choose to transmit the check digit or not

CHECK DIGIT TRANSMISSION

EAN 8



EAN 13



UPC A



UPC E



NO CHECK DIGIT TRANSMISSION

EAN 8



EAN 13



UPC A



UPC E





CODE SELECTION



CONVERSION OPTIONS

UPC E to UPC A conversion



UPC E to EAN 13 conversion



UPC A to EAN 13 conversion



EAN 8 to EAN 13 conversion



Enable only ISBN conversion



Enable only ISSN conversion

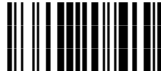

Enable both ISBN and ISSN conversion



Disable both ISBN and ISSN conversion





CODE SELECTION



2/5 FAMILY

disables the family

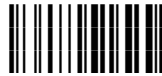

① Read the desired family code

◆ **Interleaved 2/5**



Normal 2/5 (5 Bars)



Industrial 2/5 (IATA)



Matrix 2/5 (3 Bars)



② Read a check digit selection

CHECK DIGIT TABLE

no check digit control



◆ check digit control and transmission



check digit control without transmission



③ Read 4 numbers for the code length where:

- **First 2 digits** = minimum code length.
- **Second 2 digits** = maximum code length.

The maximum code length is 99 characters.

The minimum code length must always be less than or equal to the maximum.

Examples:

0199 = variable from 1 to 99 digits in the code.

1010 = 10 digit code length only.

The pharmaceutical code below is part of the 2/5 family but has no check digit nor code length selections.

Code CIP/HR



French pharmaceutical code



CODE SELECTION



CODE 39 FAMILY

disables the family



① Read the desired family code

② Read a check digit selection

◆ Standard Code 39



CHECK DIGIT TABLE

◆ no check digit control

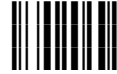

◆ Full ASCII Code 39



check digit control
and transmission



check digit control
without transmission



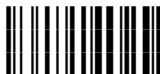

The pharmaceutical codes below are part of the Code 39 family but have no check digit selections.

Code CIP39

French pharmaceutical code

Code 32

Italian pharmaceutical code

CODE LENGTH (optional)

The code length selection is valid for the entire Code 39 family

Read the code + 4 numbers for the code length where:

First 2 digits = minimum code length.

Second 2 digits = maximum code length.

set code length



The maximum code length is 99 characters. The minimum code length must always be less than or equal to the maximum.

Examples: **0199** = variable from 1 to 99 digits in the code. **1010** = 10 digit code length only.



CODE SELECTION



CODE 128 FAMILY

disables the family



① Read the desired family code

◆ Code 128



control without transmission
of check digit

EAN 128



control without transmission
of check digit

ISBT 128



Read the ISBT 128 code and then select the appropriate concatenation code below.

◆ enable all concatenations



disable all concatenations



- Enabling ISBT 128 automatically disables Puzzle Solver™.



CODE SELECTION



CODE 93

◆ disables the code



Code 93



control without transmission
of check digit



CODE SELECTION



CODABAR FAMILY

◆ disables the family



① Read the desired equality control code

② Read a start/stop transmission selection

START/STOP CHARACTER TRANSMISSION

Standard Codabar



no start/stop character equality control

Standard Codabar



start/stop character equality control

no transmission



transmission

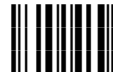

The Codabar ABC code below uses a fixed start/stop character transmission selection.

Codabar ABC



no start/stop character equality control but transmission.



CODE SELECTION



Codabar ABC Forced Concatenation

enable Codabar ABC with forced concatenation



non start/stop character equality control but transmission

CODE LENGTH (optional)

The code length selection is valid for the entire Codabar family

Read the code + 4 numbers for the code length where:

First 2 digits = minimum code length.

Second 2 digits = maximum code length.

set code length



The maximum code length is 99 characters. The minimum code length must always be less than or equal to the maximum.

Examples: **0199** = variable from 1 to 99 digits in the code. **1010** = 10 digit code length only.

START/STOP CHARACTER CASE IN TRANSMISSION

The start/stop character case selections below are valid for the entire Codabar family:

transmit start/stop characters in lower case



transmit start/stop characters in upper case



**CODE SELECTION****CODABLOCK-A**

- ◆ disables the code

**Codablock-A****Notes:**

- Enabling Codablock-A automatically disables the entire Code 39 family and vice-versa.
- Enabling Codablock-A automatically disables Puzzle Solver™.

To read stacked codes, simply move the illuminated bar over the code so that each line of the code is scanned. During this process a series of brief "ticks" indicates that reading is proceeding correctly.

CODABLOCK-F

- ◆ disables the family

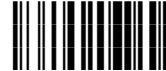
**Codablock-F Standard****Codablock-F EAN****Notes:**

- Enabling Codablock-F automatically disables Puzzle Solver™.

To read stacked codes, simply move the illuminated bar over the code so that each line of the code is scanned. During this process a series of brief "ticks" indicates that reading is proceeding correctly.



CODE SELECTION



MSI

◆ disables the family



Enable the code by selecting one of the check digit selections.

no check digit control



MOD10 check digit control
no check digit transmission



MOD10 check digit control
check digit transmission



MOD11 - MOD10 check digit control
no check digit transmission



MOD11 - MOD10 check digit control
check digit transmission



MOD10 - MOD10 check digit control
no check digit transmission



MOD10 - MOD10 check digit control
check digit transmission





CODE SELECTION



PLESSEY

◆ disables the family



Enable the code by selecting one of the check digit selections.

Standard Plessey

no check digit control



check digit control
check digit transmitted



check digit control
check digit not transmitted



Anker Plessey

no check digit control



check digit control
check digit transmitted



check digit control
check digit not transmitted





CODE SELECTION



TELEPEN

◆ disables the family



Enable the code by selecting one of the check digit selections.

Numeric Telepen

no check digit control



check digit control
check digit transmitted



check digit control
check digit not transmitted



Alphanumeric Telepen

no check digit control



check digit control
check digit transmitted



check digit control
check digit not transmitted





CODE SELECTION



DELTA IBM

◆ disables the family



Enable the code by selecting one of the check digit selections.

no check digit control



Type 1 check digit control



Type 2 check digit control





CODE SELECTION



CODE 11

◆ disables the family



Enable the code by selecting one of the check digit selections.

no check digit control



Type C check digit control
check digit transmitted



Type C check digit control
check digit not transmitted



Type K check digit control
check digit transmitted



Type K check digit control
check digit not transmitted



Type C and Type K
check digit control
check digits transmitted



Type C and Type K
check digit control
check digits not transmitted





CODE SELECTION



CODE 16K

◆ disables the code



Code 16K



To read stacked codes, simply move the illuminated bar over the code so that each line of the code is scanned. During this process a series of brief "ticks" indicates that reading is proceeding correctly.

CODE 49

◆ disables the code



Code 49



To read stacked codes, simply move the illuminated bar over the code so that each line of the code is scanned. During this process a series of brief "ticks" indicates that reading is proceeding correctly.



CODE SELECTION



PDF417

disables the code



◆ PDF417



Only for PDF417 series readers.

To read stacked codes, simply move the illuminated bar over the code so that each line of the code is scanned. During this process a series of brief "ticks" indicates that reading is proceeding correctly.

ADVANCED FORMATTING

PARAMETERS

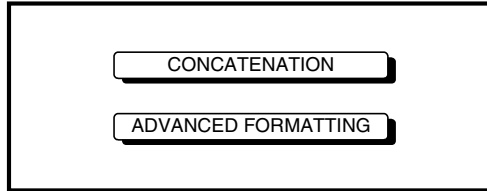

NOTE:

Please follow the setup procedure carefully for these parameters.

- 1.** Read the **Enter Configuration** code ONCE, available at the top of page .
- 2.** Read configuration codes precisely following the numbered procedure given.
 = Read the code and follow the procedure given
- 3.** Read the **Exit and Save Configuration** code ONCE, available at the top of page.



CONCATENATION

◆ disable



enable



Permits the concatenation of two codes defined by code type and length. It is possible to set a timeout for the second code reading and to define code transmission if the timeout expires.

The order of transmission is **CODE 1-CODE 2**.

Define Concatenation

1

Code 1

code ID



Read the code type from the Code Identifier Table beginning in Appendix B.

code length



Read a number in the range **01-99** from the Hex/Numeric Table.



2

Code 2

code ID



Read the code type from the Code Identifier Table beginning in Appendix B.

code length



Read a number in the range **01-99** from the Hex/Numeric Table.

3

Concatenation Result Code ID

use code 1 ID



use code 2 ID



Since you can concatenate codes from different families, you must select the Code ID character of the resulting code. The Code ID character will be sent in the output message only if it is enabled according to the Code Identifier selection (Datalogic, AIM, or Custom).

4

Concatenation Timeout

timeout



Read two numbers in the range **00 to 99**

00= no timeout

01-99 = timeout from 1 to 99 seconds

**5****Transmission after Timeout**

no code transmitted
after timeout



only code 1 transmitted
(if read) after timeout



only code 2 transmitted
(if read) after timeout



either code 1 or code 2 transmitted
after timeout



Define the timeout, which determines the valid waiting period between the two codes, in order to accept concatenation. If the timeout expires, the resulting action will be based on the following selection.

ADVANCED FORMATTING

ADVANCED FORMATTING

Advanced formatting has been designed to offer you complete flexibility in changing the format of barcode data **before** transmitting it to the host system. This formatting will be performed when the barcode data meets certain criteria which you will define in the following procedure.

Up to 4 advanced code management formats can be defined and saved in memory. For each format you must complete the entire configuration procedure:

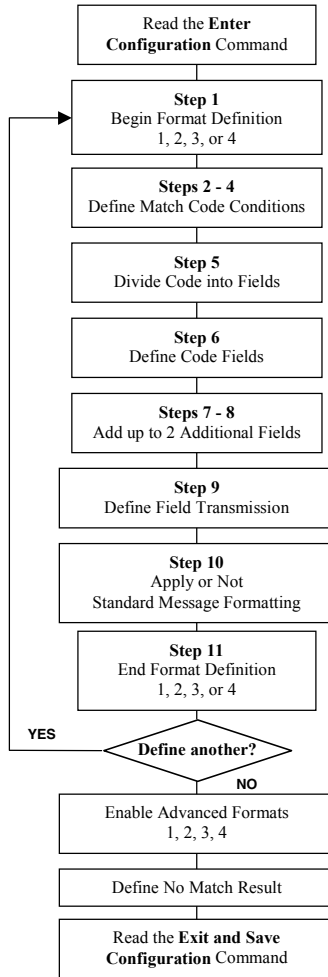



1

Begin Format Definition

begin Format 1 definition



begin Format 2 definition



begin Format 3 definition



begin Format 4 definition



2

Match Code Type

match code type



Read the above code + the code type to match from the [Code Identifier Table](#) in Appendix B.

OR

any code type



3

Match Code Length

match code length



Read the above code + two numbers in the range **01** to **99** for the exact code length.

OR

any code length



ADVANCED FORMATTING



4

Match with Predefined Characters

no match



OR

match with 1 character



match with a 2-character string



match with a 3-character string



match with a 4-character string



After selecting the predefined match code, read the character(s) from the HEX table. Range of characters = **00-7F**.

Example:

Match code with the 2-character predefined string = "@@".

Read  + 40 + 40

AND

position of first character in predefined string



Read the above code + two numbers in the range **01** to **99** representing the character position in the code where the first character of the predefined string must be found.

Read **00** if the match string can be found in any character position.

ADVANCED FORMATTING



5

Divide Code into Fields

divide code into fields



Read one number in the range 1 to 5 to divide the code into fields.

6

Define Code Fields

define code fields

Each code field length can be set by either:

- a) defining a field separator character to be found in the code itself. In this case you can choose to **discard** the code separator character or **include** it as the last character of the field.

OR BY

- b) specifying a specific character length up to the maximum of 99 characters.

OR BY

- c) selecting the last field as variable length (if any).

You must define the same number of fields as selected in step 5, including fields that will not be transmitted.

ADVANCED FORMATTING



DEFINE FIELD 1 BY: EITHER

a)  field separator



Read the field separator character from the HEX table. Range of characters = **00-7F**.

discard separator



include separator



OR

b)  field length



Read two numbers in the range **01** to **99** to define the field length.

OR

c)  this is the last field (variable length)



AND

Field 1 Terminators

no field terminators



1 field terminator



2 field terminators



Read the field terminator character(s) from the HEX table.

Valid range of characters for RS232 Interface = **00-7F**.

Valid range of characters for WEDGE Interface = **00-9B**.

ADVANCED FORMATTING



DEFINE FIELD 2 BY: EITHER

a)  field separator



Read the field separator character from the HEX table. Range of characters = **00-7F**.

discard separator



include separator



OR

b)  field length



Read two numbers in the range **01** to **99** to define the field length.

OR

c)  this is the last field (variable length)



AND

Field 2 Terminators

no field terminators



1 field terminator



2 field terminators



Read the field terminator character(s) from the HEX table.

Valid range of characters for RS232 Interface = **00-7F**.

Valid range of characters for WEDGE Interface = **00-9B**.

ADVANCED FORMATTING



DEFINE FIELD 3 BY: EITHER

a)  field separator



Read the field separator character from the HEX table. Range of characters = **00-7F**.

discard separator



include separator



OR

b)  field length



Read two numbers in the range **01** to **99** to define the field length.

OR

c)  this is the last field (variable length)



AND

Field 3 Terminators

no field terminators



1 field terminator



2 field terminators



Read the field terminator character(s) from the HEX table.

Valid range of characters for RS232 Interface = **00-7F**.

Valid range of characters for WEDGE Interface = **00-9B**.

ADVANCED FORMATTING



DEFINE FIELD 4 BY: EITHER

a)  field separator



Read the field separator character from the HEX table. Range of characters = **00-7F**.

discard separator



include separator



OR

b)  field length



Read two numbers in the range **01** to **99** to define the field length.

OR

c)  this is the last field (variable length)



AND

Field 4 Terminators

no field terminators



1 field terminator



2 field terminators



Read the field terminator character(s) from the HEX table.

Valid range of characters for RS232 Interface = **00-7F**.

Valid range of characters for WEDGE Interface = **00-9B**.

ADVANCED FORMATTING



DEFINE FIELD 5 BY: EITHER

a)  field separator



Read the field separator character from the HEX table. Range of characters = **00-7F**.

discard separator



include separator



OR

b)  field length



Read two numbers in the range **01** to **99** to define the field length.

OR

c) this is the last field (variable length)



AND

Field 5 Terminators

no field terminators



1 field terminator



2 field terminators



Read the field terminator character(s) from the HEX table.

Valid range of characters for RS232 Interface = **00-7F**.

Valid range of characters for WEDGE Interface = **00-9B**.



7

First Additional Fixed Field

no fixed field



1 character fixed field



2 character fixed field



3 character fixed field



4 character fixed field



5 character fixed field



6 character fixed field



After selecting **one** of the Additional Fixed Field codes, read the corresponding character(s) from the HEX table. Range of characters = **00-7F**.

Example:

4 Character Fixed Field



+ 4D + 41 + 49 + 4E = MAIN



8

Second Additional Fixed Field

no fixed field



1 character fixed field



2 character fixed field



3 character fixed field



4 character fixed field



5 character fixed field



6 character fixed field



After selecting **one** of the Additional Fixed Field codes, read the corresponding character(s) from the HEX table. Range of characters = **00-7F**.

Example:

3 Character Fixed Field



$$+ 53 + 45 + 54 = \text{SET}$$

ADVANCED FORMATTING



9

Field Transmission

number of fields to transmit



Read one number in the range 1 to 7 for the number of fields to transmit. **Include only fields to be transmitted.**

Field Order Transmission

Read the codes corresponding to the fields to transmit in the order in which they are to be transmitted, see example.

field 1



field 3



field 5



additional field 2



field 2



field 4



additional field 1



Example:

The barcode is divided into 2 defined fields plus 1 additional fixed field.

Transmit in the order: Field 2, Additional Field 1, Field 1.

Number of Fields
to Transmit



+ 3 +

Field 2



+

Additional Field 1



+

Field 1





10

Standard Formatting

do not apply standard formatting



apply standard formatting



After performing Advanced Formatting on the barcode read, Standard Formatting (Headers, Code Length, Code ID, Terminators) can be applied to the message to be transmitted.

11

End Format Definition

end Format 1 definition



end Format 2 definition



end Format 3 definition



end Format 4 definition





ADVANCED FORMATTING



Enable Advanced Format

◆ no Advanced Formats enabled



Advanced Format 1

enable



disable



Advanced Format 2

enable



disable

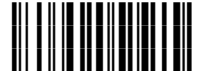

Advanced Format 3

enable



disable



Advanced Format 4

enable



disable





No Match Result

clear data - no transmission



transmit data using standard format



This selection determines the action to be taken when codes read do not conform to the advanced format requisites (no match).

- Codes not matching can be ignored, cleared from memory and not transmitted.
- Codes not matching can be transmitted using the Standard formatting (Headers, Code Length, Code ID, Terminators).

RADIO PARAMETERS

PARAMETERS

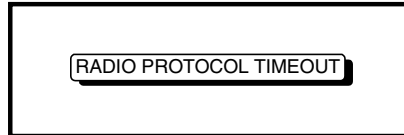

1. Read the **Enter Configuration** code ONCE, available at the top of each page.

2. Read configuration codes from the desired groups.



= Read the code and follow the procedure given

3. Read the **Exit and Save Configuration** code ONCE, available at the top of each page.



RADIO PROTOCOL TIMEOUT

radio protocol timeout



Read a number from the table where:

2-9 = timeout from **2** to **9** seconds

◆ 2 seconds

See par. 4.7.1 for details.

4 REFERENCES

4.1 RS232 PARAMETERS

4.1.1 Handshaking

Hardware handshaking: (RTS/CTS)

The RTS line is activated by the decoder before transmitting a character. Transmission is possible only if the CTS line (controlled by the Host) is active.

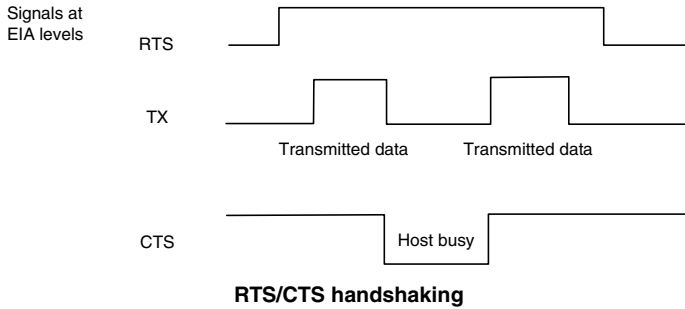

Software handshaking: (XON/XOFF)

During transmission, if the Host sends the XOFF character (13 Hex), the decoder interrupts the transmission with a maximum delay of one character and only resumes when the XON character (11 Hex) is received.

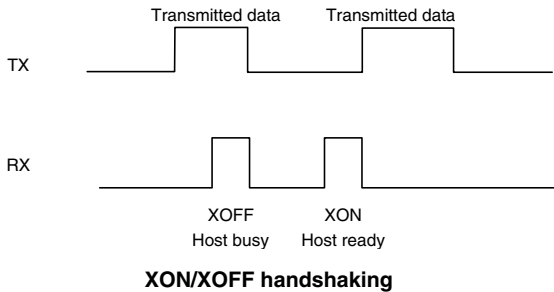

4.1.2 ACK/NACK from Host Protocol

D-Series readers: This parameter sets a transmission protocol in which the Host responds to the reader after every code transmitted. The Host sends an ACK character (06 HEX) in the case of good reception or the NACK character (15 HEX) requesting re-transmission, in the case of bad reception.

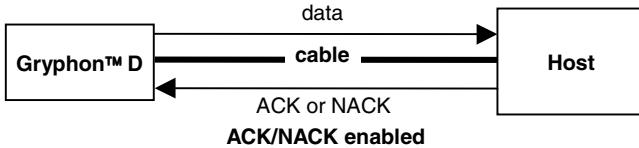

M-Series readers: The transmission protocol takes place between reader, cradle and Host. The reader passes its data (code read) to the cradle which sends it to the Host. The Host sends an ACK character (06 HEX) in the case of good reception or the NACK character (15 HEX) requesting re-transmission, in the case of bad reception. Only then does the cradle respond to the reader with the good read tone.

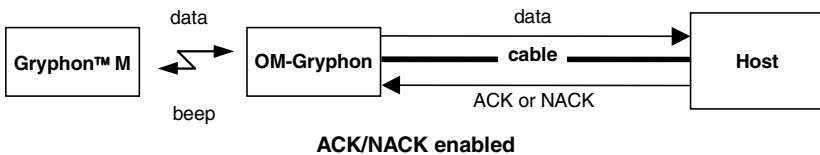
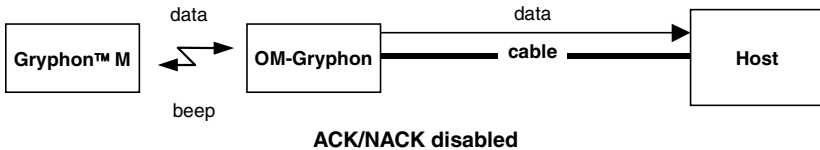

If the reader does not receive an ACK or NACK, transmission is ended after the RX Timeout (see par. 4.1.4). See also Radio Protocol Timeout, par. 4.7.1 for M-Series readers.

Selection of the ACK/NACK protocol temporarily disables FIFO buffering see par. 4.1.3.

4.1.3 FIFO

This parameter determines whether data (barcodes) are buffered on a First In First Out basis allowing faster data collection in certain cases for example when using slow baud rates and/or hardware handshaking.

If the FIFO buffering is enabled, codes are collected and sent out on the serial line in the order of acquisition. About 800 characters can be collected (buffer full), after which the reader signals an error and discards any further codes until the transmission is restored.

If the FIFO buffering is disabled, each code must be transmitted before another one can be read.

4.1.4 RX Timeout

When the RS232 interface is selected, the Host can be used to configure the device by sending it command strings (see appendix A).

This parameter can be used to automatically end data reception from the Host after the specified period of time.

If no character is received from the Host, after the timeout expires, any incomplete string (any string not terminated by <CR>) is flushed from the device buffer.

4.2 PEN PARAMETERS

4.2.1 Minimum Output Pulse

This parameter sets the duration of the output pulse corresponding to the narrowest element in the barcode. In this way the code resolution is controlled by the signal sent to the decoder, independently of the physical resolution of the code read.

The shortest pulse (200 μ s) corresponds to a high resolution code emulation and therefore a shorter transfer speed to the decoder (for decoders able to work on high resolution codes). Likewise, longer pulses correspond to low

resolution code emulation and therefore a longer transfer time to the decoder.

4.2.2 Overflow

This parameter generates a white space before the first bar and after the last bar of the code. The selections are as follows:

- narrow = space 10 times the minimum output pulse.
- medium = space 20 times the minimum output pulse.
- wide = space 30 times the minimum output pulse.

4.2.3 Output and Idle Levels

The following state diagrams describe the different output and idle level combinations for Pen emulation:

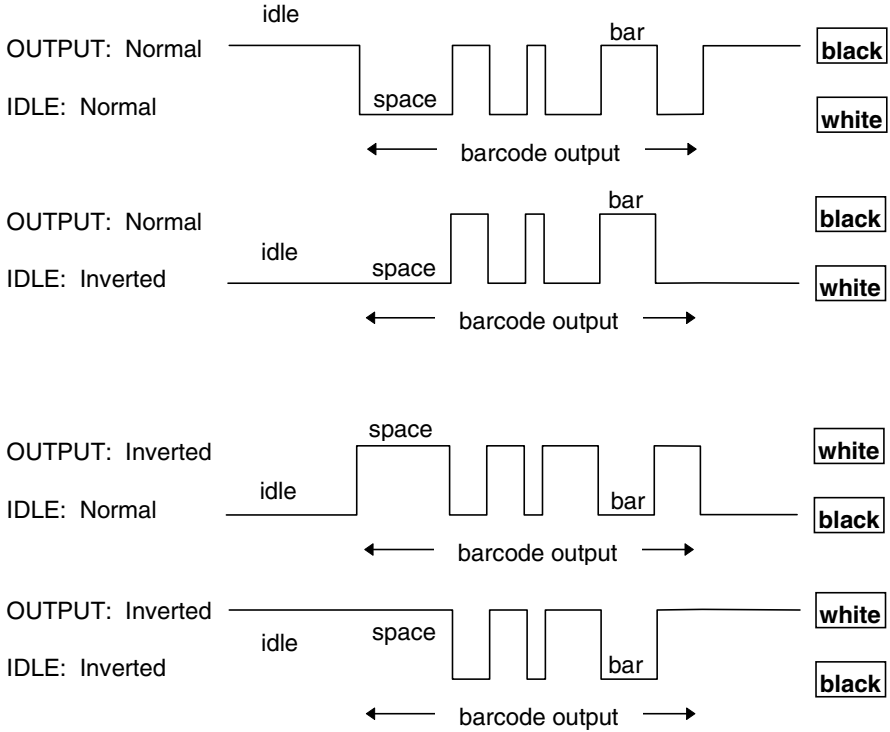

Output and Idle Levels

4.2.4 Inter-Block Delay

For the PEN Emulation interface, data are sent to the Host in fixed size blocks of 20 characters each. The inter-block delay parameter allows setting a delay between each block sent to the Host.

4.3 DATA FORMAT

4.3.1 Header/Terminator Selection

The header/terminator selection is not effected by the reading of the restore default code. In fact, header and terminator default values depend on the interface selection:

- RS232: no header, terminator CR-LF
- WEDGE: no header, terminator ENTER

These default values are always restored through the reading of RS232 or WEDGE interface selection code, see chapter 2.

For the WEDGE interface, the following extended keyboard values can also be configured:

EXTENDED KEYBOARD TO HEX CONVERSION TABLE				
HEX	IBM AT IBM 3153 APPLE ADB	IBM XT	IBM 31xx, 32xx, 34xx, 37xx	Wyse Digital
83	ENTER	ENTER	FIELD EXIT	RETURN
84	TAB	TAB	TAB	TAB
85	F1	F1	F1	F1
86	F2	F2	F2	F2
87	F3	F3	F3	F3
88	F4	F4	F4	F4
89	F5	F5	F5	F5
8A	F6	F6	F6	F6
8B	F7	F7	F7	F7
8C	F8	F8	F8	F8
8D	F9	F9	F9	F9
8E	F10	F10	F10	F10
8F	F11	ESC	F11	F11
90	F12	BACKSPACE	F12	F12
91	HOME	HOME	ENTER	F13
92	END	END	RESET	F14
93	PG UP	PG UP	INSERT	F15
94	PG DOWN	PG DOWN	DELETE	F16
95	↑	↑	FIELD -	UP
96	↓	↓	FIELD +	DOWN
97	←	←	ENTER (Paddle)	LEFT
98	→	→	PRINT	RIGHT
99	ESC	ESC		ESC
9A	CTRL (Right)	CTRL (Right)		CTRL (Right)
9B	Euro	Space	Space	Space

For M-series readers, all values from 9C to FF send the Space character.

SET CUSTOM EXTENDED HEADER/TERMINATOR KEYS

The extended Header/Terminator keys for **Wedge Interface users** can be customized by defining them through a simple keyboard setting procedure.

For example, the Numeric Keypad keys can be set for use as Headers or Terminators by substituting the default extended keys using this procedure.

The type of computer or terminal must be selected before activating the keyboard setting command.

Press and release a key to set it.

Some characters may require more than one key pressed simultaneously during normal use (refer to the manual of your PC or terminal for keyboard use). The exact sequence must be indicated to the reader in this case pressing and releasing the different keys.

Example:

If one has to press the "Shift" and "4" keys simultaneously on the keyboard to transmit the character "\$" to the video, to set the "\$", press and release "Shift" then press and release "4".

Each pressed and released key must generate an acoustic signal on the reader, otherwise repress the key. Never press more than one key at the same time, even if this corresponds to the normal use of your keyboard.

Press "Back space" to correct a wrong key entry. In this case the reader emits 2 beeps.

Note: "CAPS LOCK" and "NUM LOCK" must be off before starting the keyboard setting procedure. "SHIFT" must be repressed for each character and cannot be substituted by "CAPS LOCK".



Set Custom Extended Header/Terminator Keys



Read the code above.

- If the first 4 KEYS (Shift, Alt, Ctrl, and Backspace) are not available on your keyboard, you can only substitute them with keys not used, or substitute them with each other.
- Keys 5 to 28 must be defined

Press the desired keys in the following order:

The reader signals the end of the procedure with 2 beeps indicating the keys have been registered.

CUSTOM EXTENDED KEYBOARD SETTING TABLE		
		Custom
Order	HEX	KEY
01	-	Shift
02	-	Alt
03	-	Ctrl
04	-	Backspace
05	83	
06	84	
07	85	
08	86	
09	87	
10	88	
11	89	
12	8A	
13	8B	
14	8C	
15	8D	
16	8E	
17	8F	
18	90	
19	91	
20	92	
21	93	
22	94	
23	95	
24	96	
25	97	
26	98	
27	99	
28	9A	

4.4 POWER SAVE

4.4.1 Sleep State

This mode allows the μP in the reader to enter a “Sleep” state for minimum power consumption. For D-series readers, this command is only valid when hardware trigger type is selected.

Before entering Sleep mode, the following are verified:

- no commands coming from Host
- no data being transmitted to Host
- Enter Sleep Timeout ended (see par. 4.4.2)

To exit Sleep mode press the trigger.

Enabling the Sleep state implements Standby mode for CCD devices, see par. 4.4.3.

For M-series readers, sleep state is entered immediately after reading a code and is not configurable. To exit Sleep mode press the trigger.

4.4.2 Enter Sleep Timeout

For readers that have the Sleep state enabled, this timeout determines when the reader will enter this state.

4.4.3 Standby

If this command is enabled, part of the CCD circuitry shuts down (Standby), in order to optimize low power consumption when not reading. When the trigger is pressed this circuitry powers up. This mode causes a minor delay of about 100 ms before the reader is ready.

For M-series readers, standby is always enabled and is not configurable. To exit Standby press the trigger.

4.4.4 Power-Off Timeout (M series only)

If this command is enabled, after the desired timeout in hours, the Gryphon batteries are disconnected and all power consumption ceases. To restore power, press the trigger once. The reader will now be ready to read codes.

Power-off does not effect configuration parameters.

4.5 READING PARAMETERS

4.5.1 Operating Modes

This group of parameters allows setting different reading modes for either Hand-Held operation or Stand operation:

- SoftwareTrigger: the reader is set in FLASH MODE. Code reading takes place during the *flash on* time;
- Hardware Trigger: the code reading is started with a trigger press (ON);
- Hardware Trigger Ready: the illuminator is switched ON when the reader sees a code. It functions as a pointer aiming at the code to be read. The reading phase starts only when the trigger is pressed. In this mode the reader is automatically set to **trigger active level** and **one read per cycle** parameters. (Only for Hand-held operation).
- Automatic: The illuminator is switched ON when the reader sees a code. The reading phase starts automatically.
- Always ON: the illuminator is always ON and the reader always ready for code reading. This value is not available for M-series readers.

4.5.2 Hardware Trigger Mode

This mode determines how the reading phase is controlled when the hardware trigger operating mode is selected:

- trigger active level: the reader goes ON when the trigger is pressed and goes OFF when it is released

- trigger active pulse: the reader goes ON at the first trigger press and goes OFF only at a second press

4.5.3 Trigger-Off Timeout

When this timeout is selected, the reader turns OFF automatically after the desired period of time.

4.5.4 Reads per Cycle

In general, a **reading cycle** corresponds to the ON + OFF times of a device. The resulting effects of this parameter on code reading depend on other related configuration conditions. Here are the definitions of ON and OFF times.

- For readers using the software trigger parameter (FLASH MODE), a reading cycle corresponds to the *flash on* + *flash off* times. Code reading takes place during the *flash on* time.
- For readers using the *hardware trigger* parameter, a reading cycle corresponds to a trigger press (ON) + one of the following OFF events:
 - trigger release (for *trigger active level*)
 - a second trigger press (for *trigger active pulse*)
 - trigger-off timeout* (see par. 4.5.3).

When **one read per cycle** is selected, the device decodes only one code during the ON period and immediately turns the reader OFF. It is only possible to read another code when the next ON time occurs.

In **multiple reads per cycle**, the ON period is extended so that the device can continue decoding codes until an OFF event occurs. For software trigger mode, the *flash on* period is immediately reset after each read and therefore extended. If another code is decoded before the reset *flash on* period expires, it is again reset and the effect is that the device remains ON, decoding codes until the *flash on* or *timeout* period expires.

The Safety Time parameter should be used in this case to avoid unwanted multiple reading of the same code, see par. 4.5.5.

4.5.5 Safety Time

Safety time prevents the device from immediately decoding the same code more than once. Same code consecutive reading can be disabled requiring the reader to be removed from the code (no decoding) for at least 400 ms, or a timeout can be set up to 9.9 seconds before the decoder will accept the same code. Reading is immediate if the code changes.

4.5.6 Beeper Control for Radio Response (M series only)

For M-Series readers, the data entry good read tone normally results in two beeps; the first indicates that the reader has decoded the code, the second indicates whether OM Gryphon has received the data.

This can be changed according to the following selections:

- ◆ Normal: both good decode and good reception are signalled (two beeps).
- ◆ Only Good Decode: only the first beep indicating a good read is signalled.
- ◆ Only Good Reception: only the second beep indicating a good reception is signalled.
- ◆ Off: Neither good read nor good reception beeps are signalled.

In all cases a transmission error is always signalled.

4.6 DECODING PARAMETERS

CAUTION

These parameters are intended to enhance the decoding capability of the reader for particular applications. Used incorrectly, they can degrade the reading performance or increase the possibility of a decoding error.

4.6.1 Ink-Spread

The ink-spread parameter allows the decoding of codes which are not perfectly printed because the page texture tends to absorb the ink.

4.6.2 Overflow Control

The overflow control parameter can be disabled when decoding codes printed on small surfaces, which don't allow the use of an overflow space.

This command does not effect code families 2/5, Code 128 and Code 93.

This command is forced (enabled) when PDF417 codes are enabled.

4.6.3 Interdigit Control

The interdigit control parameter verifies the interdigit spacing for code families Code 39 and Codabar.

4.7 RADIO PARAMETERS

4.7.1 Radio Protocol Timeout

This parameter sets the valid time to wait before transmission between the M series reader and OM Gryphon cradle is considered failed.

This parameter should be set taking into consideration the radio traffic (number of readers in the same area).





If the RS232 interface is used with ACK/NACK enabled, this parameter should be at least equal to the Rx Timeout parameter for low traffic environments. It should be increased if there are many readers in the same area.

It can be set between 2 and 9 seconds.

4.8 CONFIGURATION EDITING COMMANDS



The barcode reading configuration method described in each section of chapter 3 of this manual is the most common way to configure your device.

However, additional editing commands are available and are described in this paragraph.



Command	Description
 \$+	Enter configuration environment
 \$%	Backspace - cancel an incomplete configuration sequence without exiting configuration environment
 \$/	Cancel all modifications without exiting configuration environment
 \$-	Exit and Save configuration in EEPROM

The Exit and Save command \$- can be replaced by \$) which exits saving the configuration only to RAM (without saving in EEPROM). The new configuration is valid as long as the decoder remains powered.

In this case, the following commands save in EEPROM, either the modified configuration in RAM, or the previously saved EEPROM configuration; then exit the configuration environment.

Command	Description
 \$)	End of modifications (Exit saving to RAM without saving in EEPROM)
 \$+\$(Save current configuration in RAM to EEPROM
 \$+\$.	Restore last configuration saved in EEPROM

The following commands carry out their specific function and then exit the configuration environment.

Command	Description
 \$+\$.	Restore system default configuration (see the relative Quick Reference Manual for default settings)
 \$+\$.	Transmit the Software release
 \$+\$.	The device configuration is transmitted in ASCII format. This command is not effective with Pen emulation interface.

4.9 CONFIGURATION COPYING COMMANDS

4.9.1 Copy Gryphon™ D-Series

Procedure:

- ① Connect the **master** (correctly configured reader) and the **slave** (reader to be configured) together through two RS232 serial interface cables and external power supply. Accessory cables and power supply are available from your Datalogic distributor to provide this connection.

RS232 Cables: CAB363 & CAB364 or CAB320 & CAB328

Power Supply: PG5

- ② Using the **slave** reader, read the Restore Default barcode and then the RS232 interface barcode from chapter 2 of this manual or from the Quick Reference Manual.
- ③ With the **master** reader, read the Configuration Copy barcode below.

Copy Configuration



\$+ZZ0\$-

The configuration will be copied from the master to the slave reader. The slave reader signals the end of the procedure with a series of beeps.

Note: The master reader can be configured for any interface.

4.9.2 Copy Gryphon™ M-Series

Procedure:

- ① Using the **slave** reader and its OM-Gryphon cradle, follow the initialization procedure in chapter 2 of this manual or from the Quick Reference Manual.
- ② With the **master** Gryphon™ M (correctly configured reader), read the Copy Configuration barcode below. Then place it onto an OM-Gryphon cradle within 1 minute. The reader will beep indicating the configuration has been copied.

The configuration will be simultaneously sent over the RS232 interface of the OM-Gryphon. If this causes undesired effects disconnect the RS232 cable between the PC and OM-Gryphon during this process.

Copy Configuration



\$+ZZ0\$-

- ③ With the **slave** Gryphon™ M, read the Get Configuration barcode below. Then place it onto the **same** OM-Gryphon cradle used in the step above. The slave reader's address will not be changed.

Get Configuration



\$+ZZ2\$-

The configuration will be copied from the master to the slave Gryphon™ M. The slave Gryphon™ M signals the end of the procedure with a series of beeps. It is now ready to be used with its own OM-Gryphon cradle.

- ④ Repeat the procedure above to configure other slave readers. The OM-Gryphon can continue to configure slave readers until it receives another command or data.

4.9.3 Copy OM-Gryphon

Procedure:

- ① Using the **slave** reader and its OM-Gryphon cradle, read the Restore Default barcode, set the radio address, and then read the RS232 interface barcode from chapter 2 of this manual or from the Quick Reference Manual.
- ② Connect the **master** OM-Gryphon and the **slave** OM-Gryphon (cradle to be configured) together through two RS232 serial interface cables and external power supply. Accessory cables and power supply are available from your Datalogic distributor to provide this connection.
RS232 Cables: CAB363 & CAB364 or CAB320 & CAB328
Power Supply: PG12
- ③ Read the Configuration Copy barcode below with a reader. Then place it onto the **master** OM-Gryphon cradle.

Copy Configuration**\$+ZZ3\$-**

The configuration will be copied from the master OM-Gryphon to the slave OM-Gryphon. The reader signals the end of the procedure with a series of beeps.

- ④ Repeat the procedure above to configure other slave cradles.

Note: The master OM-Gryphon can be configured for any interface.

APPENDIX A HOST CONFIGURATION STRINGS

In this section we provide a description of how to modify the device configuration using serial strings sent from the Host.

This method requires the RS232 interface.

The device configuration can be changed by receiving commands from the Host through the serial interface. When this method is used, the programming sequence format is the following:

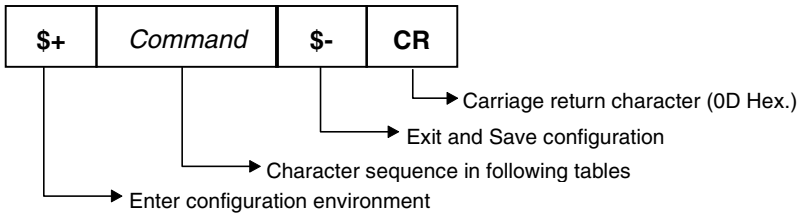

Example:

Multiple command programming sequence:

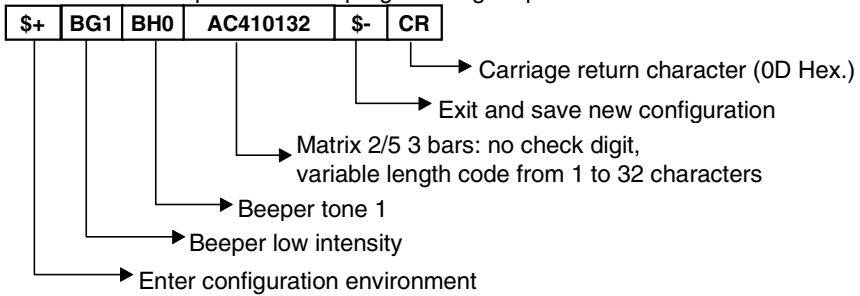

Each configuration parameter setting removes the condition previously active for that parameter.

NOTE

The device buffer can contain about 400 characters. If your programming string goes over this value, you must split it into separate groups and send each group after a delay of at least 3 seconds to give the reader time to empty the buffer and interpret the commands.

SERIAL CONFIGURATION STRINGS

ENTER/EXIT CONFIGURATION COMMANDS	
DESCRIPTION	STRING
Enter Configuration	\$+
Exit and Save Configuration	\$-
Restore Default	\$*
Transmit Software Release (not for PEN emulation)	\$!

These commands do not require \$-.

INTERFACE SELECTION		
DESCRIPTION	STRING	
RS232	CP0	
WEDGE for IBM AT	CP500	
for IBM Terminals: 31xx, 32xx, 34xx, 37xx; make-break keyboard	CP501	
for IBM Terminals: 31xx, 32xx, 34xx, 37xx; make-only keyboard	CP502	
Keyboard Type for IBM Terminals 31xx, 32xx, 34xx, 37xx	typewriter	FK0
	advanced	FK1
for IBM XT	CP503	
for IBM Terminal 3153	CP504	
for IBM PC Notebook	CP505	
for IBM SURE1	CP506	
for IBM AT - ALT mode	CP507	
for IBM PC Notebook - ALT mode	CP508	
for Wyse Terminal - ANSI Keyboard	CP509	
for Wyse Terminal - PC Keyboard	CP510	
for Wyse Terminal - ASCII Keyboard	CP511	
for Wyse Terminal - VT220 style Keyboard	CP514	
for Digital Terminals VT2xx/3xx/4xx	CP512	
for Apple ADB Bus	CP513	
PEN EMULATION	CP6	

RS232		
DESCRIPTION	STRING	
Baud rate	150	CD0
	300	CD1
	600	CD2
	1200	CD3
	2400	CD4
	4800	CD5
	9600	CD6
	19200	CD7
	38400	CD8
Parity	none	CC0
	even	CC1
	odd	CC2

RS232 (continued)		
Data bits	7	CA0
	8	CA1
	9	CA2
Stop bits	1	CB0
	2	CB1
Handshaking	disable	CE0
	RTS/CTS	CE1
	XON/XOFF	CE2
ACK/NACK Protocol	disable	CF0
	enable	CF3
FIFO	disable	EC0
	enable	EC1
Inter-character delay (<i>ms</i>)		CK00 - CK99
RX Timeout (<i>100 ms</i>)		CL00 - CL99

WEDGE		
DESCRIPTION		STRING
Keyboard nationality	Belgian	FJ7
	English	FJ4
	French	FJ2
	German	FJ3
	Italian	FJ1
	Spanish	FJ6
	Swedish	FJ5
	USA	FJ0
Caps Lock	caps Lock ON	FE1
	caps Lock OFF	FE0
Num Lock	Toggle Num Lock	FL1
	Num Lock Unchanged	FL0
Delays	Inter-Character (<i>ms</i>)	CK00 - CK99
	Inter-Code (<i>s</i>)	FG00 - FG99

PEN		
DESCRIPTION		STRING
Operating mode	interpret (does not require \$+ or \$-)	\$]
	transparent (does not require \$+ or \$-)	\$[
Minimum output pulse	200µs	DG0
	400µs	DG1
	600µs	DG2
	800µs	DG3
	1 ms	DG4
	1.2 ms	DG5
Conversion to Code 39	disable	DA0
	enable	DA1
Output level	normal	DD0
	inverted	DD1
Idle level	normal	DE0
	inverted	DE1
Overflow	narrow overflow	DH0
	medium overflow	DH1
	wide overflow	DH2
Inter-Block delay (100 ms)		CK00-CK99

DATA FORMAT		
NOT FOR PEN EMULATION INTERFACES		
DESCRIPTION		STRING
Code Identifier	disable	EB0
	Datalogic standard	EB1
	AIM standard	EB2
	Custom	EB3
Custom Code Identifier		EHabc
Headers	no header	EA00
	one character	EA01x
	two characters	EA02xx
	three characters	EA03xxx
	four characters	EA04xxxx
	five characters	EA05xxxxx
	six characters	EA06xxxxxx
	seven characters	EA07xxxxxxxx
eight characters	EA08xxxxxxxxx	
Terminators	no terminator	EA10
	one character	EA11x
	two characters	EA12xx
	three characters	EA13xxx
	four characters	EA14xxxx
	five characters	EA15xxxxx
	six characters	EA16xxxxxx
	seven characters	EA17xxxxxxxx
eight characters	EA18xxxxxxxxx	

a = ASCII character.

b, c, x = HEX values representing an ASCII character.

a = ASCII character of the DATALOGIC STANDARD Code Identifier from the table on page 28.

b = Hex value of the first Custom Code Identifier character from **00** to **7F**;
FF = disable Code Identifier

c = Hex value of the second Custom Code Identifier character from **00** to **7F**;
FF = disable second character of Custom Code Identifier

x = for D-series readers for RS232: Hex value from **00** to **7F**

x = for D-series readers for WEDGE: Hex value from **00** to **9B**

x = for M-series readers RS232 and WEDGE: Hex value from **00** to **FF**

DATA FORMAT (continued)		
NOT FOR PEN EMULATION INTERFACES		
DESCRIPTION		STRING
Code Length Tx	not transmitted	EE0
	transmitted in variable-digit format	EE1
	transmitted fixed 4-digit format	EE2
Field Adjustment	disabled	EF0
	right addition	EFa0d
	left addition	EFa1d
	right deletion	EFa2d
	left deletion	EFa3d
Field Adjustment Character		EGe
Character Replacement	disable character replacement	EO0
	first character replacement	EO1afg
	second character replacement	EO2afg
	third character replacement	EO3afg

a = ASCII character.

d = a number from the Hex/Numeric Table

e, f, g = HEX values representing an ASCII character

a = ASCII character of the DATALOGIC STANDARD Code Identifier from the table on page 29

d = a number in the range **01-32** from the Hex/Numeric Table

e = Hex value from **00** to **7F** for D-series readers; **00** to **FF** for M-series readers

f = Hex value of the character to be replaced
 from **00** to **7F** for D-series readers; from **00** to **FE** for M-series readers

g = Hex value of the new character to insert
 from **00** to **7F** for D-series readers; from **00** to **FE** for M-series readers
FF = replace with no new character (remove character)

POWER SAVE		
DESCRIPTION		STRING
Scan Rate	67 scans per sec.	BT0
	135 scans per sec.	BT1
	270 scans per sec.	BT2
Sleep State	disable	BQ0
	enable	BQ1
Enter Sleep Timeout (100 ms)		BR00-BR99
Standby	enable	BM0
	disable	BM1
Power Off Timeout (hours)		RP00-RP99

READING PARAMETERS		
DESCRIPTION		STRING
Operating Mode	hand-held operation	BP0
	stand operation	BP1
	automatic	BP2
Hand-Held Operation	software trigger	BK0
	hardware trigger	BK1
	automatic	BK2
	always on	BK3
	hardware trigger ready	BK4
Stand Operation	software trigger	BU1
	hardware trigger	BU3
	automatic	BU0
	always on	BU2
Hardware Trigger Mode	trigger active level	BA0
	trigger active pulse	BA1
Trigger-off Timeout (s)		BD00 - BD99
FLASH ON (100 ms)		BB001 - BB099
FLASH OFF (100 ms)		BB101 - BB199
Reads per Cycle	one read	BC0
	multiple reads	BC1
Safety Time (100 ms)		BE00 - BE99
Beeper Intensity	very low intensity	BG0
	low intensity	BG1
	medium intensity	BG2
	high intensity	BG3
Beeper Tone	tone 1	BH0
	tone 2	BH1
	tone 3	BH2
	tone 4	BH3
Beeper Type	monotone	BJ0
	bitonal	BJ1
Beeper Length	long	BI0
	short	BI1
PDF Decoding Recognition Intensity	low	BW0
	high	BW1
Beeper Control For Radio Response	normal	BF0
	only good decode	BF1
	only good reception	BF2
	off	BF3
Good Read Spot - Duration	disabled	BV0
	short	BV1
	medium	BV2
	long	BV3

DECODING PARAMETERS		
DESCRIPTION		STRING
Ink-spread	disable	AX0
	enable	AX1
Overflow control	disable	AW1
	enable	AW0
Interdigit control	disable	AV0
	enable	AV1
Puzzle Solver™	disable	AU0
	enable	AU1
Decoding Safety	one read	ED0
	two reads	ED1
	three reads	ED2
	four reads	ED3

CODE SELECTION			
DESCRIPTION			STRING
DISABLE ALL FAMILY CODES			AZ0
EAN/UPC	disable EAN/UPC family		AA0
	EAN 8/EAN 13/UPC A/UPC E	without ADD ON	AA1
		with ADD ON	AA5
		with and without ADD ON	AA8
	EAN 8/EAN 13	without ADD ON	AA3
		with ADD ON 2 ONLY	AAK
		with ADD ON 5 ONLY	AAL
		with ADD ON 2 AND 5	AA6
	UPC A/UPC E	without ADD ON	AA4
		with ADD ON 2 ONLY	AAM
		with ADD ON 5 ONLY	AAN
		with ADD ON 2 AND 5	AA7
	EAN 8 check digit transmission	disable	AAG0
		enable	AAG1
	EAN 13 check digit transmission	disable	AAH0
		enable	AAH1
	UPC A check digit transmission	disable	AAI0
		enable	AAI1
	UPC E check digit transmission	disable	AAJ0
		enable	AAJ1
conversions	UPC E to UPC A		AAA
	UPC E to EAN 13		AAB
	UPC A to EAN 13		AAC
	EAN 8 to EAN 13		AAD

CODE SELECTION (continued)			
DESCRIPTION		STRING	
	ISBN Conversion codes	enable ISBN	AP1
		enable ISSN	AP2
		enable ISBN and ISSN	AP3
		disable ISBN and ISSN	AP0
Code 39	disable Code 39 family		AB0
	Standard	no check digit control	AB11
		check digit control and transmission	AB12
		check digit control without transmission	AB13
	Full ASCII	no check digit control	AB21
		check digit control and transmission	AB22
		check digit control without transmission	AB23
	CIP 39		AB3
Code 32		AB4	
code length		AB*xxxx	
2/5	disable Code 2/5 family		AC0
	Interleaved 2/5	no check digit control	AC11xxxx
		check digit control and transmission	AC12xxxx
		check digit control without transmission	AC13xxxx
	Normal 2/5 5 bars	no check digit control	AC21xxxx
		check digit control and transmission	AC22xxxx
		check digit control without transmission	AC23xxxx
	Industrial 2/5 (IATA)	no check digit control	AC31xxxx
		check digit control and transmission	AC32xxxx
		check digit control without transmission	AC33xxxx
	Matrix 2/5 3 bars	no check digit control	AC41xxxx
		check digit control and transmission	AC42xxxx
		check digit control without transmission	AC43xxxx
	CIP/HR		AC5

xxxx = ASCII numbers that define the code length where:

- First 2 digits = minimum acceptable code length.
- Second 2 digits = maximum acceptable code length.

The minimum code length must always be less than or equal to the maximum.

The maximum code length for all codes is 99 characters:

Examples:

0132 = variable length from 1 to 32 digits in the code.

1010 = 10 digit code length only.

CODE SELECTION (continued)			
DESCRIPTION			STRING
Codabar	disable Codabar family		AD0
	Standard	no start/stop character equality control nor transmission	AD111
		no start/stop character equality control but transmission	AD112
		start/stop character equality control but no transmission	AD121
		start/stop character equality control and transmission	AD122
	ABC Codabar	no start/stop character equality control but transmission	AD212
	Codabar ABC forced concatenation		AD232
	code length		AD*xxxx
	start/stop character case in transmission	lower case	ADA0
upper case		ADA1	
Code 128	disable Code 128 family		AI0
	enable Code 128 - control without transmission of check digit		AI11
	enable EAN 128 - control without transmission of check digit		AI21
ISBT 128	enable ISBT 128		AI31
	enable all concatenations	=&FNC3=<=>103d1	
	disable all concatenations	=&FNC3=<=>103d0	
Code 93	disable Code 93 family		AK0
	enable Code 93 - control without transmission of check digit		AK1
Codablock-A	disable		AO0
	enable		AO1
Codablock-F	disable the family		AN0
	enable Standard		AN1
	enable EAN		AN2

xxxx = ASCII numbers that define the code length where:

- First 2 digits = minimum acceptable code length.
- Second 2 digits = maximum acceptable code length.

The minimum code length must always be less than or equal to the maximum.

The maximum code length for all codes is 99 characters:

EXAMPLES:

0132 = variable length from 1 to 32 digits in the code.

1010 = 10 digit code length only.

CODE SELECTION (continued)		
DESCRIPTION		STRING
MSI	disable the family	AE0
	no check	AE1
	MOD10 no tx	AE2
	MOD10 with tx	AE3
	MOD11-MOD10 no tx	AE4
	MOD11-MOD10 with tx	AE5
	MOD10-MOD10 no tx	AE6
Plessey	MOD10-MOD10 with tx	AE7
	disable the family	AF0
	Standard no check	AF11
	Standard check - with tx	AF12
	Standard check - no tx	AF13
	Anker no check	AF21
	Anker check - with tx	AF22
Telepen	Anker check - no tx	AF23
	disable the family	AL0
	Numeric no check	AL11
	Numeric check - with tx	AL12
	Numeric check - no tx	AL13
	Alpha no check	AL21
	Alpha check - with tx	AL22
Delta IBM	Alpha check - no tx	AL23
	disable the family	AH0
	no check	AH1
	Type 1 check	AH2
Code 11	Type 2 check	AH3
	disable the family	AG0
	no check	AG1
	Type C with tx	AG21
	Type C no tx	AG22
	Type K with tx	AG31
	Type K no tx	AG32
	Type C and K with tx	AG41
Code 16K	Type C and K no tx	AG42
	disable	AJ0
Code 49	enable	AJ1
	disable	AM0
PDF417	enable	AM1
	disable	AR0
	enable	AR1

RADIO PARAMETERS	
DESCRIPTION	STRING
Radio Protocol Timeout	enable (seconds) RH2-RH9

APPENDIX B CODE IDENTIFIER TABLE

2/5 Interleaved

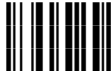

2/5 Industrial



2/5 normal 5 bars



2/5 matrix 3 bars



EAN 8



EAN 13



UPC A



UPC E



EAN 8 with 2 ADD ON



EAN 8 with 5 ADD ON



EAN 13 with 2 ADD ON

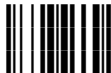

EAN 13 with 5 ADD ON



UPC A with 2 ADD ON



UPC A with 5 ADD ON



UPC E with 5 ADD ON



Code 39 Full ASCII



ABC CODABAR



EAN 128



CIP/39



Code 32



UPC E with 2 ADD ON



Code 39



CODABAR



Code 128



Code 93



CIP/HR



ISBT 128



CODABLOCK-A



CODABLOCK-F Standard



CODABLOCK-F EAN



MSI



Plessey Anker



Plessey Standard



Delta IBM



Telepen



Code 16K



Code 11



PDF417



Code 49



APPENDIX C HEX AND NUMERIC TABLE

**OPEN THIS PAGE TO READ THE DESIRED
HEX AND NUMERIC SELECTIONS**

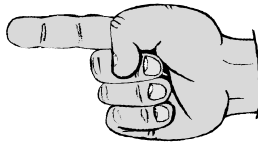

HEX / NUMERIC TABLE

CHARACTER TO HEX CONVERSION TABLE					
char	hex	char	hex	char	hex
NUL	00	*	2A	U	55
SOH	01	+	2B	V	56
STX	02	,	2C	W	57
ETX	03	-	2D	X	58
EOT	04	.	2E	Y	59
ENQ	05	/	2F	Z	5A
ACK	06	0	30	[5B
BEL	07	1	31	\	5C
BS	08	2	32]	5D
HT	09	3	33	^	5E
LF	0A	4	34	`	5F
VT	0B	5	35	a	61
FF	0C	6	36	b	62
CR	0D	7	37	c	63
SO	0E	8	38	d	64
SI	0F	9	39	e	65
DLE	10	:	3A	f	66
DC1	11	;	3B	g	67
DC2	12	<	3C	h	68
DC3	13	=	3D	i	69
DC4	14	>	3E	j	6A
NAK	15	?	3F	k	6B
SYN	16	@	40	l	6C
ETB	17	A	41	m	6D
CAN	18	B	42	n	6E
EM	19	C	43	o	6F
SUB	1A	D	44	p	70
ESC	1B	E	45	q	71
FS	1C	F	46	r	72
GS	1D	G	47	s	73
RS	1E	H	48	t	74
US	1F	I	49	u	75
SPACE	20	J	4A	v	76
!	21	K	4B	w	77
"	22	L	4C	x	78
#	23	M	4D	y	79
\$	24	N	4E	z	7A
%	25	O	4F	{	7B
&	26	P	50		7C
'	27	Q	51	}	7D
(28	R	52	~	7E
)	29	S	53	DEL	7F
		T	54		



0



2



4



6



8



A



C



E



1



3



5



7



9



B



D



F

Backspace



Cancels an incomplete configuration sequence



90ACC1780